

SMD Seam Sealing Crystals 5.0 x 3.2 x 0.9 mm

Features

- High precision characteristics covering up to wide frequency range.
- Higher frequency stability and reliability.
- Excellent for reducing EMI effect.
- The best choice of Bluetooth, wireless communication set, DSC, PDA, mobile phone and USB interface card.
- RoHS Compliant / Pb Free.

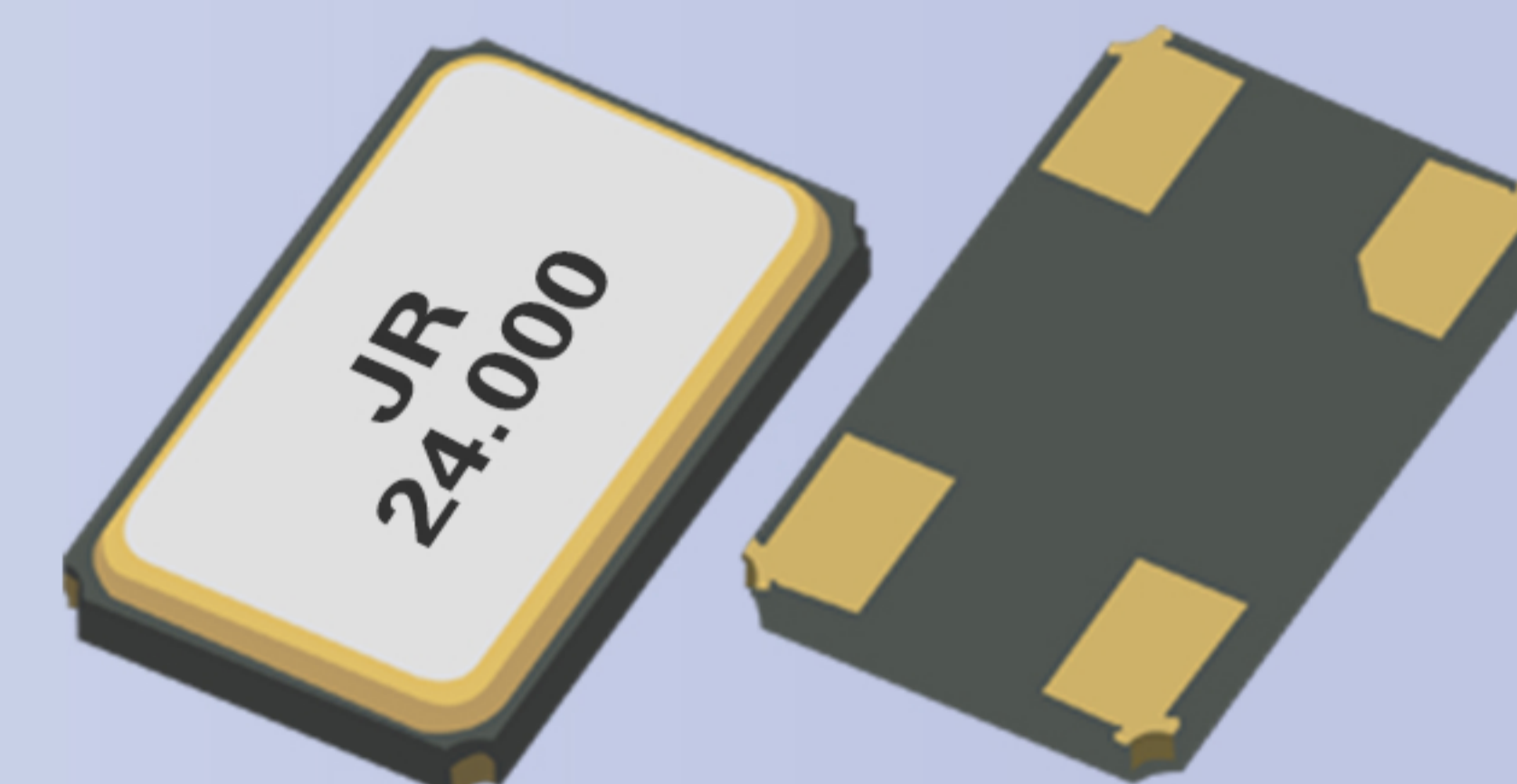

Electrical Specifications

Item / Type	5032	
Frequency Range	8 ~ 125MHz	
Frequency Tolerance (at 25 °C)	± 10 ppm	
Frequency Stability Over Operating Temperature Range	± 10 ppm	
Operating Temperature Range	-40-85°C	
Shunt Capacitance (C0)	5 pF Max. (2 pF typical)	
Drive Level	1 ~ 200 μW (100 μW typical)	
Load Capacitance	10 pF, 16 pF, 20 pF, or specify	6 pF, 9 pF, 10 pF, 12 pF, 16 pF
Aging (at 25 °C)	± 3 ppm / year Max.	± 1 ppm / year Max.
Storage Temperature Range	- 40 ~ + 85 °C	

Equivalent Series Resistance(ESR)

Fundamental		3rd Overtone	
8 ~ 11 MHz	80 Ω Max.	40 ~ 60 MHz	120 Ω Max.
12 ~ 54 MHz	40 Ω Max.	60 ~ 125 MHz	80 Ω Max.

Dimensions

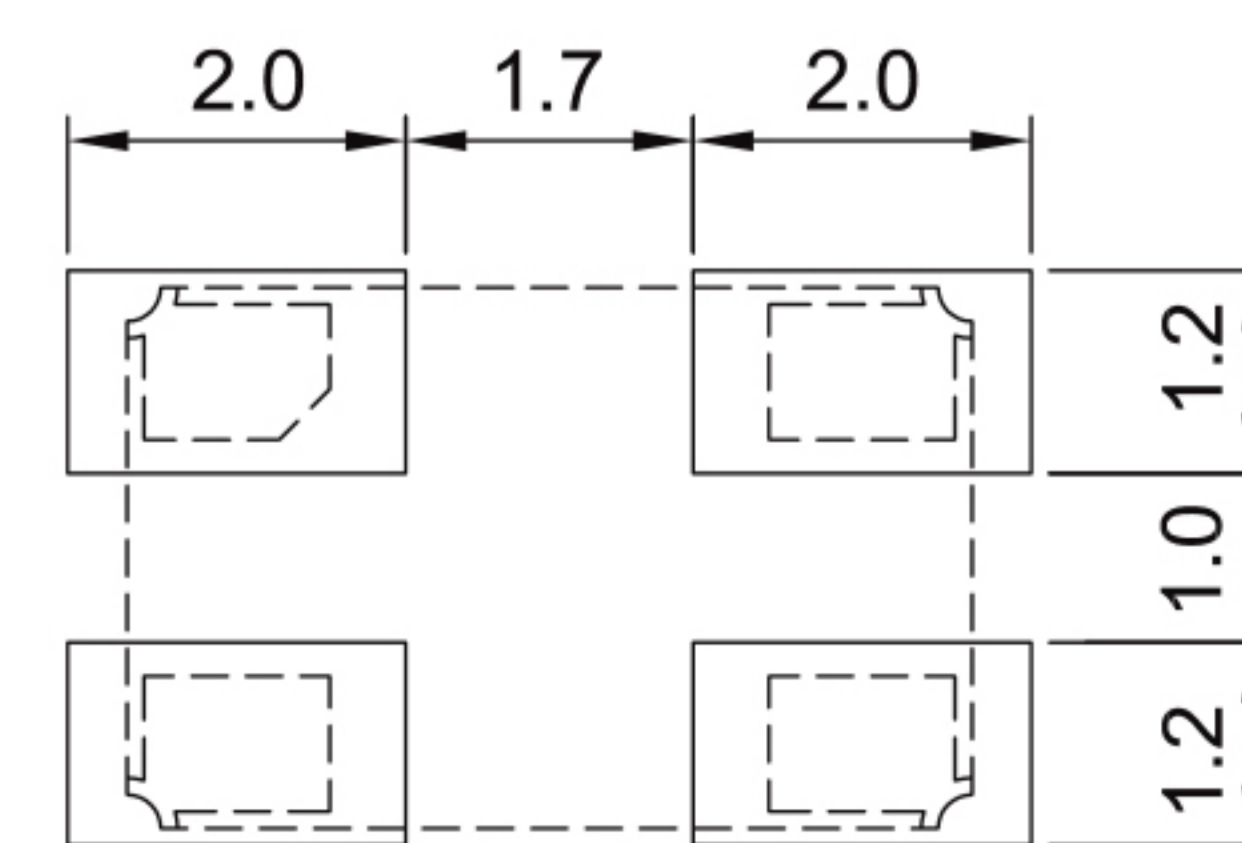
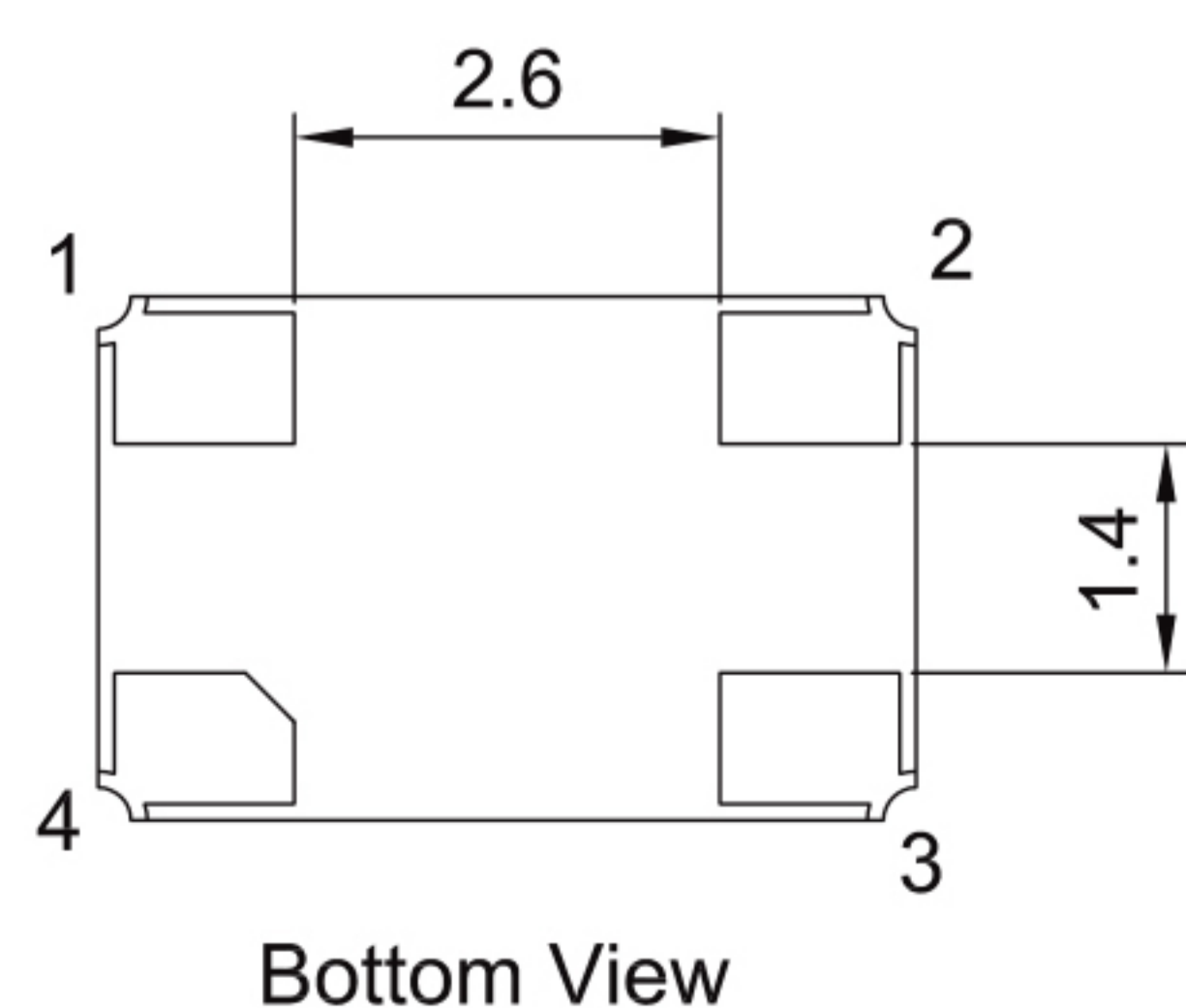
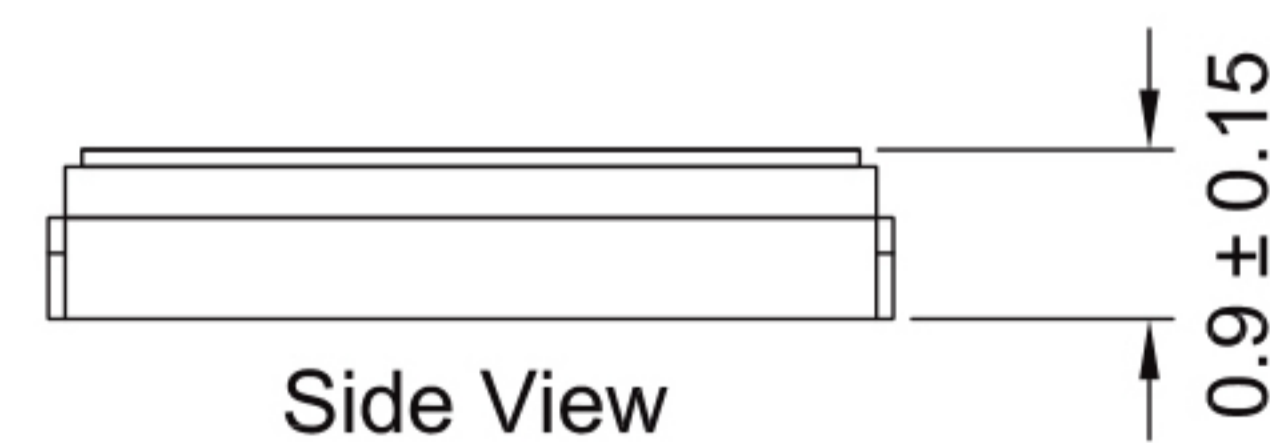
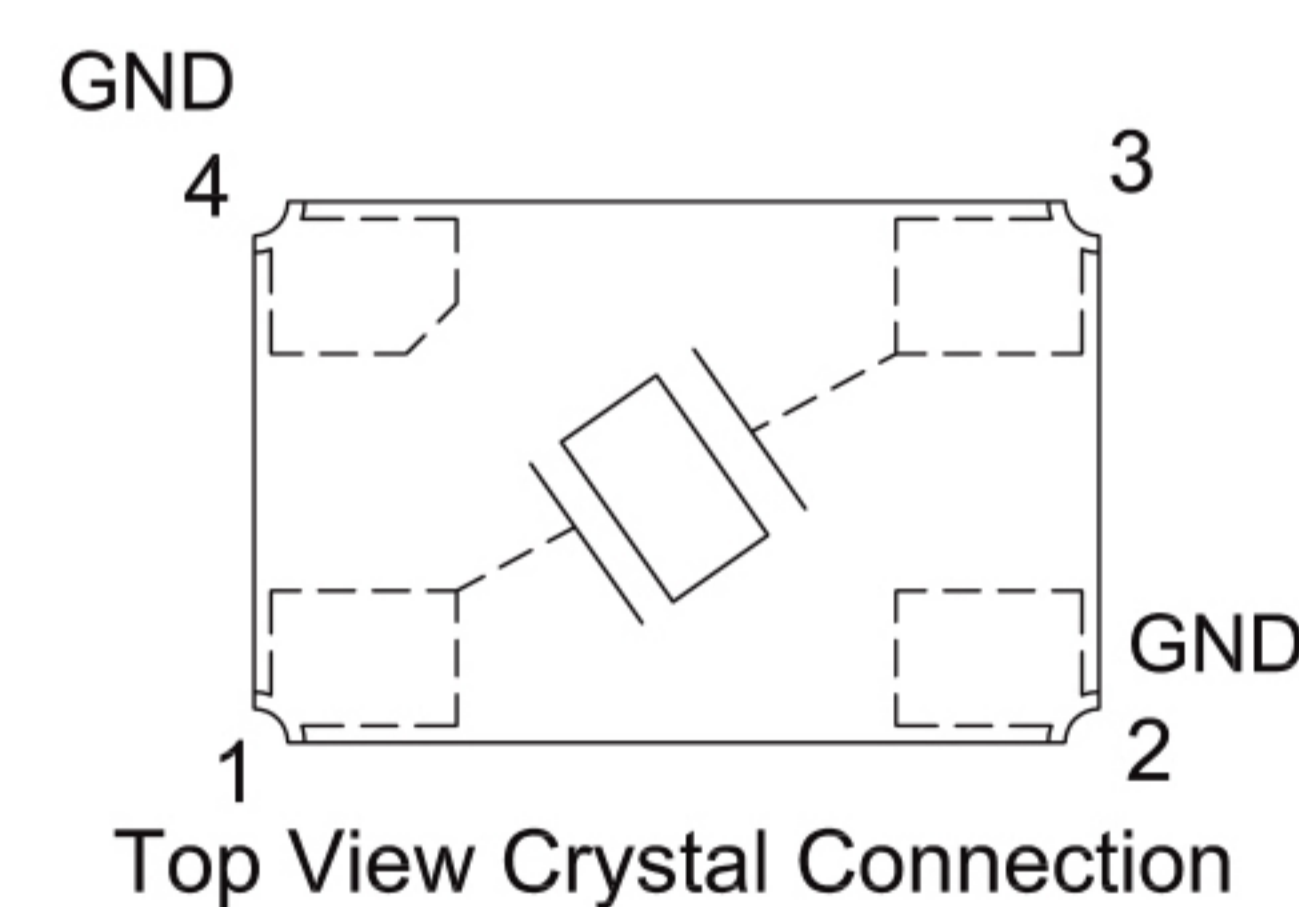
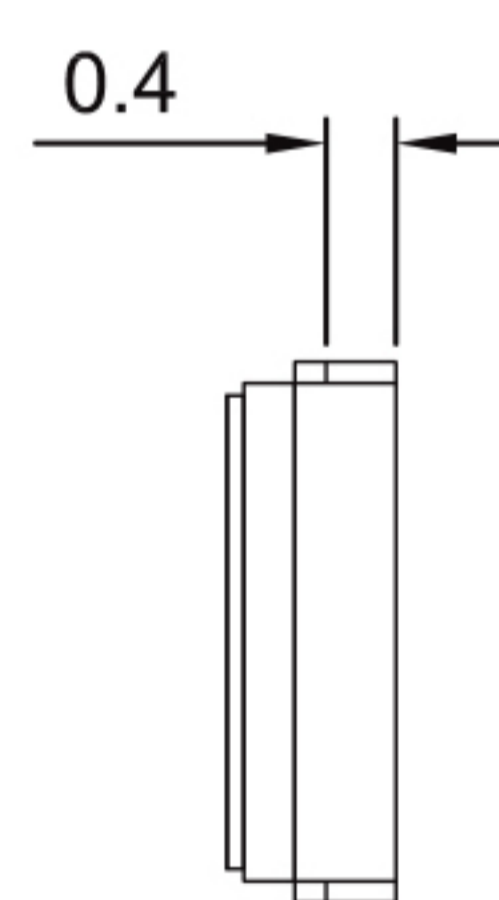
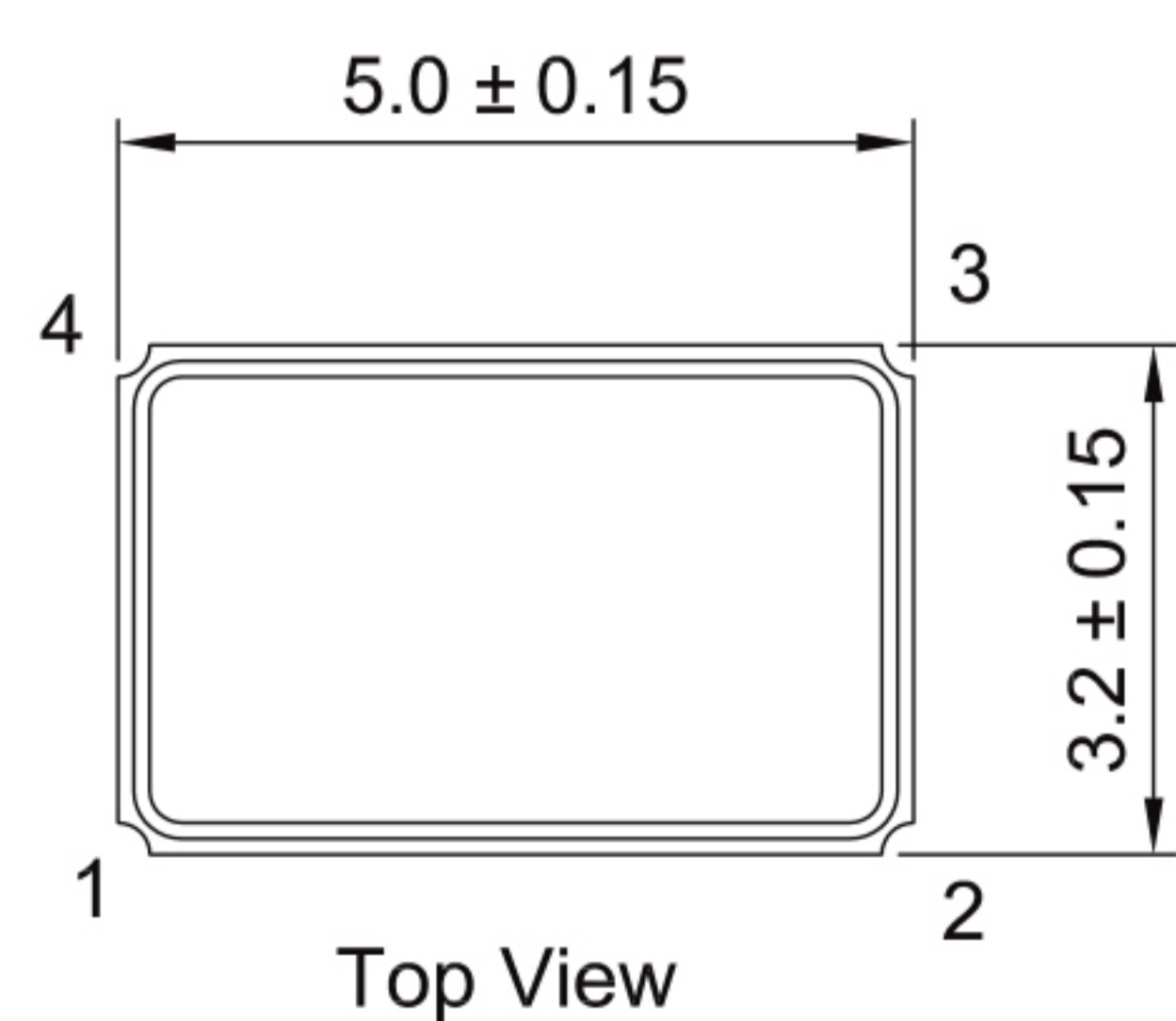

Units: mm