

Product Features

1. Output Frequency : 1 ~ 200MHz
2. Frequency Stability : ± 25 , ± 50 ppm
3. Supply Voltage : 1.8 , 2.5 , 3.3V
4. Operating Temperature : -40~105°C
5. Output Type : CMOS
6. Phase Jitter : 1ps (Max.) @100MHz , 3.3V
7. RoHS and REACH Compliant , Pb-free , Halogen-free
8. Fast Delivery
9. Industry Standard Package :
2.0 x 1.6 x 0.75 mm

Application :

- NB , PC , Tablet , Smartphone , PC peripherals , IPC , Server , Storage , Ethernet , USB , etc.
- Audio ADC , Video , AI Vision Processing Unit , CPLD , FPGA , CPU , GPU , MCU , BMC , etc.



Test condition
Ambient temperature : $25 \pm 5^\circ\text{C}$
Relative humidity : 40% ~ 70%

● Table 1 . Electrical Specifications

Parameters	Symbol	Min.	Typ.	Max.	Units	Notes
Frequency Range and Stability						
Nominal Frequency	F	1 ~ 156.25			MHz	@ 2.5 V 、 3.3 V
		1 ~ 125				@ 1.8 V
Frequency Tolerance	FT	± 25			ppm	@ -40~85°C , Note 1
		± 50				@ -40~105°C , Note 1
Operating Temperature Range						
Operating Temperature	Topr	-40	25	105	°C	
Supply Voltage and Current Consumption						
Supply Voltage	Vdd	1.8 , 2.5 , 3.3 ($\pm 10\%$)			V	
Current Consumption	Icc	-	-	25	mA	
Standby Current	Icc(ST)	-	-	10	uA	OE = Low
CMOS Type Signal Characteristics						
Output Load : CMOS	CL	15			pF	
Output Voltage High	VoH	90%Vdd	-	-	V	Vdd @ 2.5 or 3.3 V
		Vdd-0.4	-	-		Vdd @ 1.8 V
Output Voltage Low	VoL	-	-	10%Vdd	V	Vdd @ 2.5 or 3.3 V
		-	-	0.4		Vdd @ 1.8 V
Rise Time	Tr	-	-	5	ns	10% → 90% Vdd Level
		-	-	4		20% → 80% Vdd Level
Fall Time	Tf	-	-	5	ns	90% → 10% Vdd Level
		-	-	4		80% → 20% Vdd Level
Symmetry (Duty ratio)	TH/T	45	~	55	%	

Note 1: Inclusive of frequency tolerance at 25°C , variation over temperature, supply voltage variation, aging and vibration.

Test condition
Ambient temperature : $25 \pm 5^\circ\text{C}$
Relative humidity : 40% ~ 70%

● **Table 1 . Electrical Specifications (continued)**

Parameters	Symbol	Min.	Typ.	Max.	Units	Notes
Startup and Resume time						
Start-up Time	Tosc	-	-	10	ms	To 90% of Final Amplitude
Output Disable Delay Time	T off	-	-	250	us	
Output Enable Delay Time	T on	-	-	300	us	
Enable Pin Control and Input Characteristics						
Enable Control	-	Yes			-	Pad 1
Enable Voltage High	VIH	70%Vdd	-	-	V	
Disable Voltage Low	VIL	-	-	30%Vdd	V	
Aging Performance						
Aging	-	± 3			ppm/yr.	1st. Year at 25°C
Jitter Performance						
RMS Phase Jitter Fout range : 10MHz~40MHz @ Integrated from 12KHz ~ 5MHz Note1	PJ	-	-	1.0	ps	
RMS Phase Jitter Fout range : 40MHz~200MHz @ Integrated from 12KHz ~ 20MHz Note1	PJ	-	-	1.0	ps	

Note 1 : Phase Jitter will be slightly different according to output frequency and supply voltage.

● **Test Diagram**

Pad 1(OE)	Pad 3 (Output)	Oscillator
High (or open)	OSC out	Normal operation
Low	High impedance	Stop oscillation

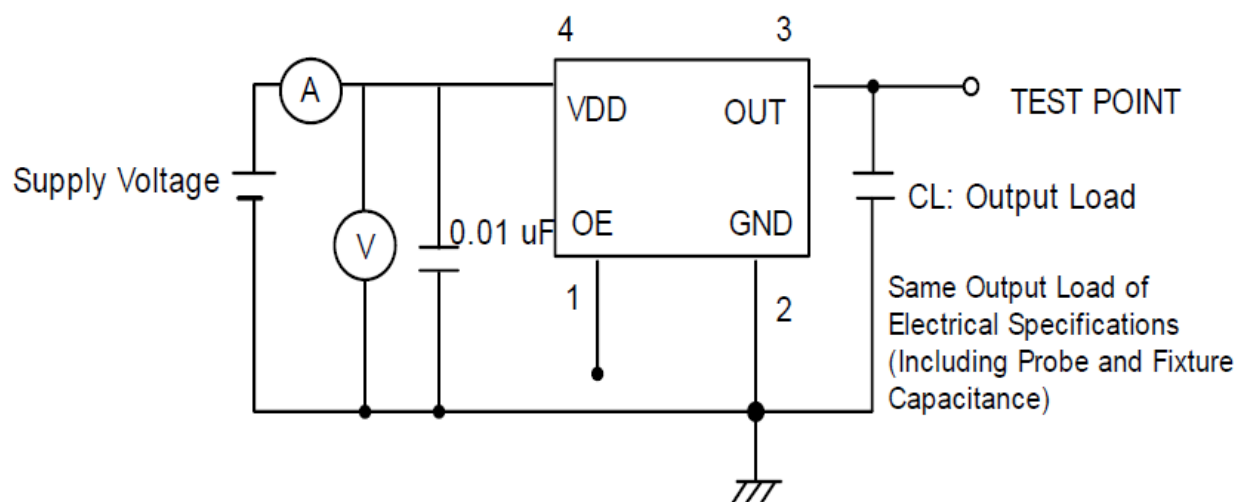

Note : TXC sets CL to 15pF for simulation IC load. Customer does not need to layout it in reality circuit.

● **Waveform Conditions**

Waveform measurement system should have a min. bandwidth of 5 times the frequency being tested.

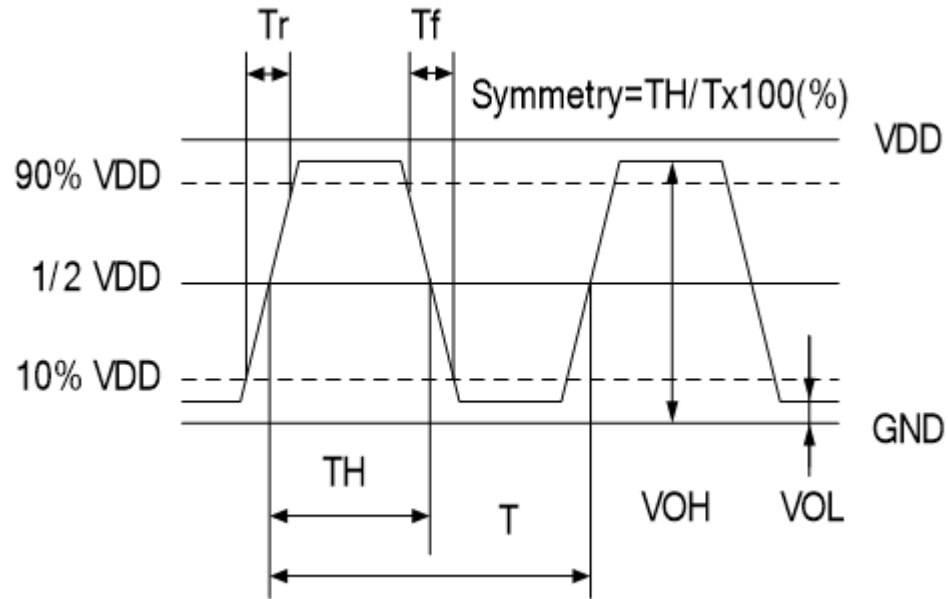

● **Dimensions & Footprint (Recommended)**

Unit : mm

